

16

17

**A FORCE  
OF NATURE  
SINCE 1781.**

[www.ochsenkopf.com](http://www.ochsenkopf.com)



**OCHSENKOPF**  
BY GEDORE



OCHSENKOPF  
BY HILDEBRAND

9

# GERMANY'S OLDEST AXE FORGE

OCHSENKOPF stands for perfection and safety in forestry and carpentry tools. Since the Fahlefeld Bros. established the firm in 1781, the best steel with the best cut has been forged to a maximum quality in the Remscheid factory. An OCHSENKOPF axe stands for top-grade craftsmanship. It is still the pride of the traditional tool industry in "Bergisches Land". A brand like a myth.

Axe-making has been developed over time into a highly modern industrial undertaking. Quality and service have top priority.

OCHSENKOPF tools are preferably manufactured of C60 steel. One of its features is its incredible toughness, which guarantees long tool life.

Only high-quality wood is used in tool shaft production. Hickory is a high-grade and extremely break-proof wood. Instead of being sharpened to a knife edge, OCHSENKOPF tools are honed to a cambered edge, which results in longer edge life.

So much more could be said about the brand considered by professionals to be the be-all and end-all. But basically you have to experience OCHSENKOPF. When working with wood. In the dark, deep forest.

# MANUFACTURE OF AN AXE

Out of the forge and into the forest



**1**

The forged blanks are sawn off from rolled C60 tempering steel.



**2**

The red-hot blank is shaped on a forging press and the hole is made for the eye. Excess burring is removed.



**3**

The glowing blade is beaten out on the forging roll.



**4**

Final shaping under the forging hammer. Trimming excess material and rough-grinding the axe.



**5**

Permanent marking by means of a stamp bearing the manufacturer's symbol. Tempering (hardening and tempering) the cutting edge ensures hardness and toughness.



**6**

Sand-blasting the surface. Fine-grinding the cutting edge. A crowned cut increases stability. Transparent varnish protects the axe head from corrosion.



**7**

Inserting and clamping the handle. The triple clamp provided by one wooden wedge and two ring wedges ensures a lasting and safe connection.

# EXCELLENT QUALITY

Test seals from qualified inspection bodies certify the high quality of OCHSENKOPF tools



#### KWF-Profi

Forestry tools and work aids that have been extensively tested by the Kuratorium für Waldarbeit und Forsttechnik e.V. (KWF) in Groß-Umstadt, are awarded the “KWF-Profi” test seal.

They meet all the requirements of the latest technical practice, including economy and the standards relating to safety-at-work, ergonomics and environmental compatibility. The tests encompass technical measurements, tests in forestry use and practical surveys. The new “KWF-Profi” test seal replaces the older FPA “acorn” label. For over 50 years the trademark for tested forest technology.



#### KWF-Standard

Both the newly launched KWF test seal “STANDARD” and the “KWF-Profi” test seal include a complete utility value test. The “STANDARD” seal of approval is especially for products which set themselves apart from the high demands of professional forestry deployment. In this way an occasional user, such as one acquiring his own firewood, can rely on tested safety.



#### VPA GS

Tested safety by the institution for testing and checking (VPA) in Remscheid. For more than 50 years, VPA has been intensively involved in testing hand tools.



#### Dreipilz

The “Dreipilz” quality seal is awarded for processing high-grade steels in conjunction with continuous monitoring by the institution for testing and checking (VPA) in Remscheid.

## Guaranteed quality: For your safety

- First-rate professional tools for safe professional work
- Since over 235 years quality tools forged in Germany
- Axe heads made from durable and resistant C60 steel = highest possible quality
- Limited analysis of the steel grade = best possible wear resistance
- Crowned cut = efficient cutting performance with long service life
- The axe handles are also manufactured in Germany. Use of woods from selected growing areas.
- Multiple safety wedging of the axe heads
- Certified quality by well-known testing institutes



## Wood chopping: Notes on Use



- 1** Before starting work, always ensure that there is sufficient safety distance from any other persons and objects.
- 2** Wear suitable protective clothing, for example safety glasses and safety shoes.
- 3** A wide, approximately knee-high chopping block placed on a flat surface provides the ideal basis for wood chopping. Place the piece of wood to be split on the chopping block and take the splitting axe in both hands. The right hand holds the end of the handle, while the left hand grips the upper part of the handle just below the axe head (for left handers, the reverse applies).
- 4** Raise the axe and, as you bring the axe down slide the left hand along the handle to the end against your right hand. Often one stroke is enough to split smaller pieces of wood. For large chunks of wood, aluminium wedges can be used as an aid and must be driven in with appropriate tools such as a splitting hammer. Steel wedges must be driven in only with a hard wood or plastic hammer.

## The various applications require specially adapted tools

To simplify the search for the right tool, our products are accordingly identified with their intended purpose:



Axes for lopping, felling and arboriculture maintenance



Axes and hatchets for universal use



Splitting tools

# The right choice of tool for wood splitting and felling

The choice also of course depends on the user's physical size and condition. Thus, for instance, a well-built, strong user will be far more at home with a heavy axe and long handle than someone who is smaller.









A universal axe can be used for felling, de-branching and wood splitting. If an axe is solely for splitting work, then preference should be given to the splitting axe over the universal axe on account of its wedge-shaped head geometry.

A handle protective sleeve not only protects the handle. Head heaviness of the tool is also heightened by the extra 300 g weight. That is why the lighter SPALT-FIX® axe with a 1250 g head weight has a greater penetrating power than a comparable axe head

without a handle protective sleeve. For driving in wedges (only plastic or aluminium ones for safety reasons - no steel wedges), the most suitable tool is the 3 kg BIG OX® splitting hammer. This is very much done to its large striking surface head and the protective sleeve protecting the wooden handle below the head from damage when striking is not always true.

As wood permeated by branch roots is extremely difficult to split, the best thing here is to use a heavy splitting axe or a splitting hammer.

The following overview and information help you in coming to a decision on the right tool.

	Felling and branch-cutting work	Easier splitting work up to Ø 25 cm Length max. 30 mm	Medium-strenuous splitting work Ø 25 - 40 cm Length max. 30 mm	Strenuous splitting work as of Ø 40 cm Length max. 30 mm	Metre-length sections	with wedge (aluminium or plastic)
<b>ILTIS®-axes</b> 	✓ ✓ ✓	✗	✗	✗	✗	✗ ✗
<b>Universal-axes</b>  up to 1250 g	✓ ✓	✓	✗	✗	✗	✗ ✗
<b>SPALT-FIX® 1250g, 50 cm handle</b> 	✗	✓ ✓ ✓	✓	✗	✗	✗ ✗
<b>SPALT-FIX® 1250g, 70 cm handle</b> 	✗	✓ ✓ ✓	✓ ✓	✓	✗	✗ ✗
<b>SPALT-FIX® 2500g</b> 	✗	✓	✓ ✓ ✓	✓ ✓ ✓	✓ ✓	✗ ✗
<b>Mallet-type axe 2750g</b> 	✗	✓	✓ ✓	✓ ✓ ✓	✓ ✓ ✓	✓
<b>Splitting hammer 3 kg</b> 	✗	✓	✓ ✓	✓ ✓ ✓	✓ ✓ ✓	✓ ✓ ✓ ✓
<b>Splitting hammer 3,5 kg</b> 	✗	✓	✓ ✓	✓ ✓ ✓	✓ ✓ ✓	✓ ✓
<b>Recoilless wedge hammer</b> 	✗ ✗	✗ ✗	✗ ✗	✗ ✗	✗ ✗	✓ ✓ ✓ (also for steel wedges)

✓ ✓ ✓ optimally suited    ✓ ✓ well suited    ✓ suited    ✗ not suited    ✗ ✗ must not be used

# IDENTIFY QUALITY

RING WEDGE

VS

FLAT WEDGE

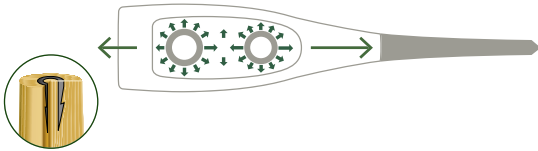

The tapered collar evenly distributes the clamping force across 360° i.e. also in the direction of motion. The wood fibre structure is not ruined. There is no slackening of the axe head even after several hundred strikes. The barbed hook ensures a positive fit and stops the tapered collar from loosening. A safety "extra".

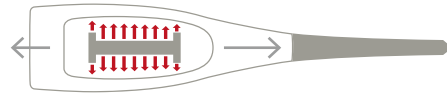

No clamping force in the direction of motion thanks to the flat wedge.

CROWNED CUTTING FORM

VS

KNIFE-EDGE SHARPENING

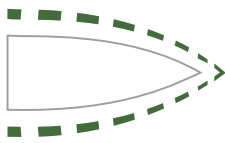

It is true that the crowned cutting form does not have that keenness look, but the splitting effect is nevertheless the same. The considerably longer service life from a crowned cut reduces the frequency of re-grinding. This, in turn, raises tool service life and saves on both time and costs.

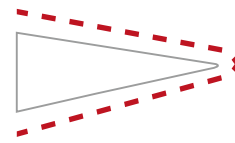

Although the keenness is readily apparent from knife-edge sharpening, the cutting edge quickly becomes blunt from renewed striking and therefore needs to be re-ground more often.

HICKORY HANDLES

VS

ASH HANDLES



- North American tree species of the walnut family
- High-grade and extremely break-proof wood. Hickory is capable of 3-4 times the physical loading of ash
- Long-fibre structure: increased safety in a handle breakage - the long fibres hold the wood together, avoiding uncontrolled release of the broken-off handle and the axe/hatchet head
- Vibration damping
- Long life = extremely good value for money

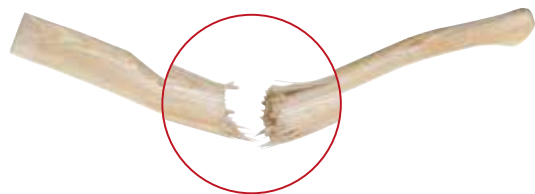

- Native tree species in Europe
- Wood specified in DIN as the minimum grade
- Low-cost
- Break-proof
- Short-fibre structure: in the event of a break, the short fibres of the wood are unable to hold the break point together. The handle breaks in two parts.



# THE ROTBAND-PLUS SYSTEM

The original: more safety and effectiveness



The ROTBAND-PLUS range at a glance:

**Pro-wood splitting hammer** BIG OX® No. OX 635 H > p. 11

**Splitting axe** ROTBAND-PLUS No. OX 630 H > p. 14

**SPALT-FIX® axe** ROTBAND-PLUS No. OX 648 H > p. 14

**Universal GOLD forestry axe** ROTBAND-PLUS No. OX 620 H > p. 16

**SPALT-FIX® hatchet** ROTBAND-PLUS No. OX 644 H > p. 15



# BIG OX® PRO-WOOD SPLITTING HAMMER

Wood splitting made easy



Extra large striking face

High-grade hickory handle. Extremely rigid and break-proof

Long handle protective steel sleeve

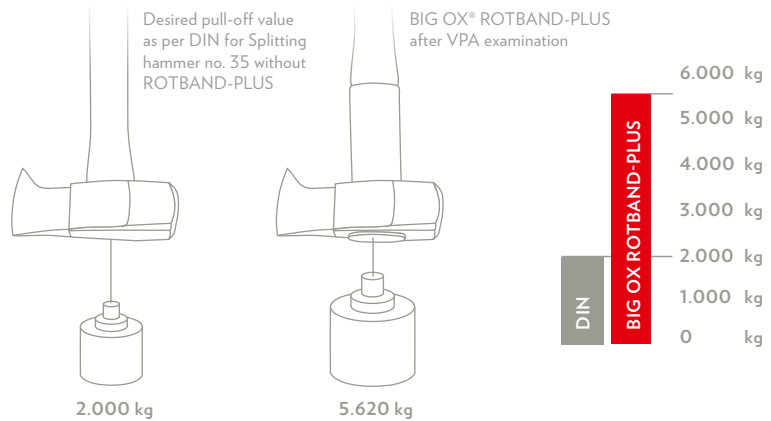

Double certified safety by means of increased pull-off values

**Safety system that sets standards:** long handle protective steel sleeve, tapered collar, fixing plate and wood screw form the head and shaft into a unit.

**Absolutely safe joint** between the handle and head. Long life and maximum work safety - even if the axe slips

**ROTBAND-PLUS spare handles** are available complete with a handle protective steel sleeve, tapered collar, fixing plate and wood screw. With **KWF-Profi** and **VPA GS test seals**.



## OX 635 H wood splitting hammer professional BIG OX®

- With handle join ROTBAND-PLUS
- Forged hammer head with turning nose and extra large striking face, e.g. for driving wedges
- With high-quality hickory handle and blade-protection. End of handle rounded for extra comfort
- The spare handle is delivered completely with protective sleeve, tapered collar, fixing plate and wood screw
- With the ROTBAND-PLUS spare handle the wood splitting hammer no. OX 35 E + H can be converted to a ROTBAND-PLUS model



Code	No.	Test seal					Spare handle
1707663	<b>OX 635 H-3009</b>	KWF, GS	3000	70	900	4200	OX E-696 H-0850



## OX 35 E & H wood splitting hammer professional

- Forged hammer head with turning nose and extra large striking face, e.g. for driving wedges
- With high-quality ash (OX 35 E-) or hickory (OX 35 H-) handle and blade-protection. End of handle rounded for extra comfort.
- With the spare handle OX E-696 H-0850 the no. OX 35 E and no. OX 35 H can be converted to a ROTBAND-PLUS model



Code	No.	Test seal					Spare handle
1591789	<b>OX 35 E-3001</b>	KWF, GS	3000	70	850	3800	OX E-86 E-0850
1591797	<b>OX 35 H-3009</b>	KWF, GS	3000	70	850	3800	OX E-96 H-0850



## OX 638 H wood splitting hammer ROTBAND-PLUS

Slim pattern

- With handle join ROTBAND-PLUS
- Forged hammer head with long cut and turning nose
- The slim shape makes it ideal for splitting softwood
- With high-quality hickory handle and blade-protection. End of handle rounded for extra comfort.
- The spare handle is delivered completely with protective sleeve, tapered collar, fixing plate and wood screw



Code	No.	Test seal					Spare handle
1881353	<b>OX 638 H-3509</b>	KWF, GS	3500	80	900	5000	OX E-638 H-3500



# SPLITTING AXES

Chopping wood rapidly and easily



With high-quality ash handle, end of handle rounded for extra comfort

Optimum splitting results, less force required due to wedge-shaped blade

## ROTBAND-PLUS: More safety and effectiveness

### Handle join

Handle sleeve, tapered collar, fixing plate and wood screw bond the hammer head and the handle into one unit and ensure an optimum in safety.

### Long service life

The long handle sleeve made of steel protects the handle from damage when the hammer misses its target. This guarantees a long service life.

**Spare handle ROTBAND-PLUS** available complete with handle sleeve, tapered collar, fixing plate and wood screw. With test seal **KWF-Profi** and **VPA GS**, double certified safety.



## OX 648 H Axe SPALT-FIX® ROTBAND-PLUS

- Optimum splitting results. Less force required due to wedge-shaped blade
- With handle join ROTBAND-PLUS
- With high-quality hickory handle. End of handle rounded for extra comfort.
- The spare handle is delivered completely with protective sleeve, tapered collar, fixing plate and wood screw
- With the ROTBAND-PLUS spare handle the axe SPLIT-QUICK no. OX 248 can be converted to a ROTBAND-PLUS model



Code	No.	Test seal					Spare handle
1962396	<b>OX 648 H-1257</b>	KWF, GS	1250	100	700	2150	OX E-648 H-1250
1852701	<b>OX 648 H-2508</b>	KWF, GS	2500	115	800	3550	OX E-648 H-2500



## OX 630 H SPLITTING Axe ROTBAND-PLUS

- With handle join ROTBAND-PLUS
- Ideal for splitting softwood
- With high-quality hickory handle
- The spare handle is delivered completely with protective sleeve, tapered collar, fixing plate and wood screw
- With the ROTBAND-PLUS spare handle the wood splitting hammer no. OX 30 can be converted to a ROTBAND-PLUS model



Code	No.	Test seal					Spare handle
2336537	<b>OX 630 H-2757</b>	KWF, GS	2750	120	900	4250	OX E-630 H-2750



## OX 30 E SPLITTING Axe

- Ideal for splitting softwood
- With high-quality ash handle. End of handle rounded for extra comfort.







Code	No.	Test seal					Spare handle
1591762	<b>OX 30 E-2751</b>	KWF, GS	2750	120	850	3800	OX E-85 E-0850



## OX 248 E Axe SPALT-FIX®

- Optimum splitting results, less force required due to wedge-shaped blade
- Long service life, little weight
- With high-quality ash handle. End of handle rounded for extra comfort.
- With the spare handle OX E-648 H-2500 the no. OX 248 E-2501 can be converted to a ROTBAND-PLUS model
- With the spare handle OX E-648 H-1250 the no. OX 248 E-1257 can be converted to a ROTBAND-PLUS model







Code	No.	Test seal					Spare handle
1953338	<b>OX 248 E-1257</b>	KWF STD, GS	1250	100	700	1850	OX E-84 E-0700
1591703	<b>OX 248 E-2501</b>	KWF PRO, GS	2500	115	800	3250	OX E-84 E-0800



## OX 644 H Hatchet SPALT-FIX® ROTBAND-PLUS

- Optimum splitting results. Less force required due to wedge-shaped blade
- With handle join ROTBAND-PLUS
- With high-quality hickory handle. End of handle rounded for extra comfort.
- The spare handle is delivered completely with protective sleeve, tapered collar, fixing plate and wood screw
- With the ROTBAND-PLUS spare handle the no. OX 244 can be converted to a ROTBAND-PLUS model







Code	No.	Test seal					Spare handle
1852728	<b>OX 644 H-1255</b>	KWF, GS	1250	100	500	1950	OX E-644 H-1250



## OX 244 E Hatchet SPALT-FIX®

- Optimum splitting results, less force required due to wedge-shaped blade
- Long service life, little weight
- With high-quality ash handle. End of handle rounded for extra comfort.
- With the spare handle no. OX E-644 H-1250 the no. OX 244 can be converted to a ROTBAND-PLUS model



Code	No.	Test seal					Spare handle
1591738	<b>OX 244 E-1251</b>	KWF, GS	1250	100	500	1650	OX E-84 E-0500

# OCHSENKOPF GOLD AXES

For universal use

Fine polished axe head







High-quality handle

## OX 620 H Universal forestry axe ROT BAND-PLUS

Rhineland pattern

- Indispensable in wood-working and gardening
- With handle join ROTBAND-PLUS: Handle sleeve, tapered collar, fixing plate and wood screw bond the hammer head and the handle into one unit and ensure an optimum in safety
- The long handle sleeve made of steel protects the handle from damage when the hammer misses its target. This guarantees a long service life.
- Fine polished axe head with blade-protection
- With high-quality hickory handle
- The spare handle is delivered completely with protective sleeve, tapered collar, fixing plate and wood screw
- With the spare handle OX E-620 H-1250 the axe no. OX 20 in sizes 1000 g and 1250 g can be converted to a ROTBAND-PLUS model



Code	No.	Test seal					Spare handle
1879812	<b>OX 620 H-1257</b>	KWF, GS	1250	120	700	2100	OX E-620 H-1250







## OX 20 H Universal forestry axe

Rhineland pattern

- Indispensable in wood-working and gardening
- Fine polished axe head with blade-protection
- With high-quality handle made of hickory wood
- With the spare handle no. OX E-620 H-1250 the models 1000 g and 1250 g can be converted to a ROTBAND-PLUS model



Code	No.	Test seal					Spare handle
1591045	<b>OX 20 H-1007</b>	GS	1000	120	700	1600	OX E-94 H-0700
1591061	<b>OX 20 H-1257</b>	KWF, GS	1250	120	700	1850	OX E-94 H-0700
1591304	<b>OX 20 H-1407</b>	GS	1400	130	800	2150	OX E-94 H-0800
1591320	<b>OX 20 H-1608</b>	GS	1600	130	800	2350	OX E-94 H-0800









## OX 209 E Axe EUROPE

Rhineland pattern

- For universal use
- Cutting edge polished, with blade-protection
- With ash handle



Code	No.	Test seal					Spare handle
1591037	<b>OX 209 E-1002</b>	KWF, GS	1000	120	700	1600	OX E-83 E-0600
1591398	<b>OX 209 E-1252</b>	KWF, GS	1250	120	700	1850	OX E-83 E-0700
1591401	<b>OX 209 E-1402</b>	GS	1400	130	800	2150	OX E-83 E-0800
1591428	<b>OX 209 E-1602</b>	GS	1600	130	800	2350	OX E-83 E-0800







## OX 25 H Axe

Harz pattern

- Cutting edge fine polished
- With high-quality handle made of hickory wood







Code	No.	Test seal					Spare handle
1591487	<b>OX 25 H 1107</b>	KWF	1100	120	700	1700	OX E-94 H-0700



## OX 235 E Forestry hatchet

- Indispensable in wood-working and gardening
- Cutting edge fine polished
- With high-quality ash handle





Code	No.	Test seal					Spare handle
1591649	<b>OX 235 E-0602</b>	KWF, GS	600	105	360	900	OX E-78 E-0360
1591657	<b>OX 235 E-0802</b>	KWF, GS	800	110	380	1100	OX E-78 E-0380
1591665	<b>OX 235 E-1002</b>	GS	1100	125	410	1300	OX E-78 E-0410



## OX 270 GST All-steel hatchet

- Practical companion for camping and leisure
- Ideal for splitting small pieces of wood (kindling)
- The reverse of the hatchet head can be used to hammer in tent pegs, etc.
- Head and handle forged from one piece
- Extremely strong and robust
- With plastic handle
- Packed in a leather pouch with belt loop for safety and convenience



Code	No.				
1735934	<b>OX 270 GST-600</b>	600	85	320	880

# ILTIS® HIGH-PERFORMANCE FORESTRY AXE

According to the principles of Dr. Gottfried Reissinger

Author of the book: "The construction basics of the axe"

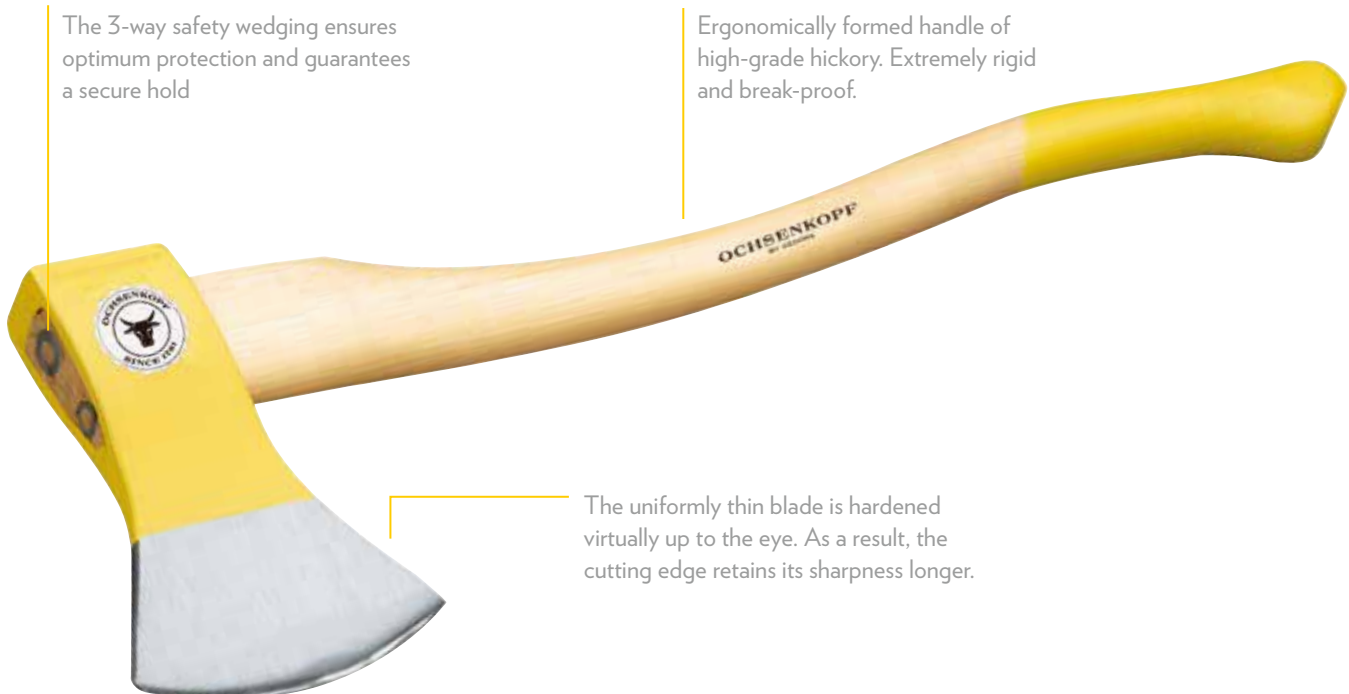

The 3-way safety wedging ensures optimum protection and guarantees a secure hold

Ergonomically formed handle of high-grade hickory. Extremely rigid and break-proof.

The uniformly thin blade is hardened virtually up to the eye. As a result, the cutting edge retains its sharpness longer.

The uniformly thin blade is hardened virtually up to the eye

#### Reduced risk of breaking

The thin, springy blade absorbs the bending forces on every impact. This significantly reduces the risk of breaking and correspondingly extends the life.

#### Low weight

Greater cutting power with less application of force. More ergonomic and efficient working.

#### Easy re-sharpening

From the cutting edge to the eye, the blade is forged uniformly thin and carefully hardened. If professionally re-sharpened, there is no need to re-harden.

#### Special steel

The design of this type of axe, with the described advantages, is possible only by using this high-grade special steel. Even at low temperatures, this steel remains viscoplastic, thereby allowing continuous use in extremely cold weather and on all types of hardwood.



## OX 10 H Axe ILTIS®

Model Europe

- For debarking, felling and cultivation
- The uniformly thin blade, hardened virtually up to the eye, ensures a high utility value
- Can be easily re-sharpened by the user
- Blade fine polished, with blade-protection
- With high-quality handle made of hickory wood



Code	No.	Test seal					Spare handle
1591177	<b>OX 10 H-0807</b>	KWF	800	135	700	1800	OX E-94 H-0700
1591193	<b>OX 10 H-1207</b>	KWF, GS	1200	145	700	2100	OX E-94 H-0700



## OX 15 H Axe ILTIS® (chain-saw axe)

Model Canada

- For debarking, felling and cultivation
- The uniformly thin blade, hardened virtually up to the eye, ensures a high utility value
- Can be easily re-sharpened by the user
- Blade fine polished, with blade-protection
- With high-quality hickory handle



Code	No.	Test seal					Spare handle
1591207	<b>OX 15 H-0807</b>	KWF	800	110	700	1400	OX E-95 H-7000
1591215	<b>OX 15 H-1007</b>	KWF	1000	125	700	1600	OX E-95 H-7000



## OX 16 H Axe ILTIS® -DOUBLE-BIT

Model Canada

- The top model of the Canadian lumbermen - with 2 edges, e.g. for two different cuts on one axe
- For debarking, felling and cultivation
- The uniformly thin blade, hardened virtually up to the eye, ensures a high utility value, long life and low weight
- Can be easily re-sharpened by the user
- Blade fine polished, with blade-protection
- With high-quality hickory handle. End of handle rounded for extra comfort.



Code	No.					Spare handle
1591223	<b>OX 16 H-1008</b>	1000	135	900	2100	OX E-99 H-9000

# COMPETITION AXES

Specially developed for competition use





For all requirements to competition axes and the tournament rules please visit [www.ochsenkopf.com](http://www.ochsenkopf.com)



## OX 18 H Throwing axe

- Perfect balance for optimum flight
- Especially designed for the demands of contests
- Form and execution are up to the competition standards
- With consecutive serial number
- Axe head forged and fine polished
- With high-quality hickory handle. Very appealing optic through a special wood treatment.
- 3x wedging of the handle effects a non-detachable handle join
- With high-quality leather blade-protection



Code	No.					Spare handle
1591630	<b>OX 18 H-1206</b>	1200	150	750	2000	OX E-99 H-0750



## OX 440 H Champion axe

- With special grinding for training\*
- Made of special steel
- Triple safety wedge
- With high-quality hickory handle and leather blade-protection

\* **Note:** Do not use the axe on frozen wood! Only use on soft wood, e.g. poplar.



Code	No.				Spare handle
1592696	<b>OX 440 H-2708</b>	190	800	3300	OX E-453 H-0800



If you would like more detailed information about our competition items, please contact us. We will be happy to help.  
E-mail: [sport@ochsenkopf.com](mailto:sport@ochsenkopf.com)



### Foot and shin protection

Made of stainless steel. As protection in the event of the axe slipping. For wearing underneath clothing and inside shoes.



### Angle gauge

Of stainless steel to precisely determine the cutting-edge angle (13°-17°)

Since 2002 OCHSENKOPF is the official German supplier to the STIHL® TIMBERSPORTS® SERIES



“Work in the forest presents fresh challenges every day for man and tool alike. The tools I have must be ones to rely on - whatever the conditions. It is vital to have both good and safe tools in your hands. That is why OCHSENKOPF tools are always with me.”

DIRK BRAUN, TWO-TIMES EUROPEAN CHAMPION AND SEVEN-TIMES  
GERMAN CHAMPION OF THE STIHL® TIMBERSPORTS® SERIES.

# WEDGES

Aluminium, plastic or steel

Back

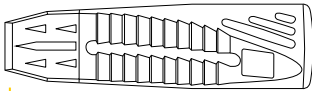

**Barbed hook**  
to stop any slipping out

**Guide rib**  
for straight driving-in in the direction of strike

**Saw profile**  
to stop any slipping out



## OX 41 Twisted aluminium splitting wedge oval



Awarded with the "BMELV Forsttechnikpreis 2012" (Forestry Technology Prize)

- Forged safety splitting wedge, made of high-quality aluminium
- The wedge is twisted by 30° for extremely effective splitting
- The oval form provides optimum use and a greater striking face
- Impacts and damages of the outer striking face are minimised
- Acute angled grooves on the front, additional saw-tooth on the back and barbed hooks on both sides prevent slipping out and spring-back, even in frozen wood
- Guide ribs allow a straight drive in
- Extremely rugged
- Only suitable for splitting, no felling wedge!
- DBGM (German utility patent)



Code	No.	Test seal	max. stroke height	L	W	
2598558	OX 41-1000	KWF	60	225	65	1000



Do observe our safety instructions for all kinds of wedges on page 38

## Advantages of aluminium wedges

- High safety: no splintering of the surface by using steel hammers (no steel on steel)
- Extremely light-weight and very stable
- No dangerous repulsion of the chain-saw on touching the wedge



## OX 42 Aluminium massive wedge

- Forged safety wedge, DBGM\*, made of high-quality aluminium
- Particularly suitable for felling and splitting
- Acute angled grooves on the front and double longitudinal grooves on the back prevent from jerking back of the wedge
- Suitable for all felling operations including frozen wood
- Extremely strong and little weight

\* German Utility Patent

Can be used with the holder for wedges OX 127-0000 (page 33)



Code	No.	Test seal	max. stroke height	L	W	
1591878	<b>OX 42-0550</b>	KWF, GS	35	215	45	550
1820486	<b>OX 42-0850</b>	KWF, GS	35	265	55	850
1591142	<b>OX 42-1050</b>	KWF, GS	40	260	60	1050



## OX 43 Aluminium chainsaw cutting and felling wedge

- Forged safety wedge made of aluminium
- Acute angled grooves on the front and double longitudinal grooves on the back prevent from jerking back of the wedge
- Especially suitable for use with motor saw

Code	No.	max. stroke height	L	W	
1591940	<b>OX 43-0510</b>	27	140	100	485



## OX 44 – OX 45 Aluminium hollow-wedge

- Forged from high-quality aluminium
- For felling and splitting
- With double longitudinal grooves on the front and back side
- Particularly developed for bigger wood diameter
- Available with exchangeable wood shaft and aluminium ring or wear- and weather-proof plastic shaft (DBGM\*)
- The shaft extends the wedge effect and thus enables a higher splitting and spreading effect
- The aluminium ring of the wood shaft prevents from splintering when driving
- Aluminium massive wedge complete = Aluminium hollow-wedge, wood shaft, aluminium ring

\* German Utility Patent



Code	No.	Description	Test seal	max. stroke height	L	W	
1591886	<b>OX 45-0650</b>	Aluminium hollow-wedge, complete	KWF	58	360	72	940
1591908	<b>OX 44-0000</b>	Aluminium hollow-wedge	KWF		170	72	500
1591916	<b>OX 46-0000</b>	Wood shaft loose					360
1591924	<b>OX 47-0000</b>	Aluminium ring loose, internal dia.-Ø 53 mm					80
1591932	<b>OX 49-0000</b>	Plastic shaft, white					400



## OX 31 – OX 34 Plastic felling wedge

- Made of high-quality polyamide plastic
- Extremely impact-resistant and especially suitable for felling, even in extreme cold
- Optimum wedge effect even in frozen wood

**Safety Note:** Only suitable for felling - not suitable for splitting

Can be used with the holder for wedges OX 127-0000 (page 33)



Code	No.	Description	Test seal	max. stroke height	L	W	
1592041	<b>OX 32-0100</b>	Plastic felling wedge, YUKON type	KWF	25	180	65	150
1592068	<b>OX 31-0300</b>	Plastic felling wedge, ALASKA type	KWF	30	230	70	250
1592076	<b>OX 34-0400</b>	Plastic felling wedge, LABRADOR type	KWF	40	245	75	400



## OX 40 Steel wedge

- Forged solid wedge with guide groove

**Safety Note:** Use only hardwood or plastic hammers to drive in steel wedges. Hitting steel on steel can lead to splintering.

Code	No.	max. stroke height	L	W	
1591975	<b>OX 40-2000</b>	31	250	54	2000
1591983	<b>OX 40-3000</b>	40	270	56	3000



## OX 36 H Recoilless wedge hammer

- Suitable for safely driving in steel, aluminium and plastic wedges
- For special surface protection = reduces material wear and thus longer service life of the wedges
- Can also be used for driving in fence posts
- Due to the special filling insert in the hammer head, a considerable higher striking force is reached compared to standard engineer's and recoilless hammers
- Dead blows with no recoil reduces stress on muscles, nerves and wrists
- Splinter-proof, shatter-proof and wear-resistant polyamide heads, 75 Shore D, tested to -20° C
- With high-quality hickory handle. End of handle rounded for extra comfort.

Can be used with the professional forestry belt OX 125-0000 (page 33)

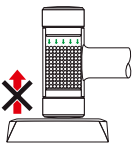

Code	No.	Description	Test seal	Head	Lenght of head L		Spare handle
2703327	<b>OX 36 H-2609</b>	Recoilless wedge hammer	KWF	70	2600	175	900 3000 OX E-36 H-2600
2820838	<b>OX 36-2600</b>	Polyamid spare head (1 piece)		70	2600		





## OX 60 Bark spud

Black Forest pattern

- Ideally suited for removing tree bark
- With distorted socket
- Delivered without handle



Code	No.	Test seal	Blade  *mm	  *mm	 g	Spare handle
1592610	<b>OX 60-0650</b>	KWF	140	1180	650	OX E-87 E-0950



## OX 62 Bark spud

Daun pattern

- For easy removal of bark and thin branches
- With distorted socket
- Three edged
- Delivered without handle





Code	No.	Test seal	Blade  *mm	  *mm	 g	Spare handle
1592637	<b>OX 62-0800</b>	KWF	140	1180	800	OX E-87 E-1180



## OX 63 – OX 64 Bark spud

- For removing bark
- Delivered without handle

Code	No.	Execution	Blade  *mm	  *mm	 g	Spare handle
1592645	<b>OX 63-0400</b>	light pattern	110	1180	400	OX E-87 E-0950
1592653	<b>OX 64-0550</b>	heavy pattern	140	1180	550	OX E-87 E-0950



## OX 58 Felling lever

- Powerful, efficient and ergonomic
- Turning hook and plate forged
- Robust steel profile
- With non-slip, ergonomic handle of cork
- Adjustable turning hook
- With angled handle for improved handling
- **OX 58-0800:**  
Use: As felling aid and for moving up to a diameter at breast height of 25 cm
- **OX 58-1200:**  
Use: As felling aid up to a diameter at breast height 25 cm  
For moving up to a diameter at breast height 35 cm

### Safety note:

- Felling lifter are only approved for one-man work
- Maximum load on the handle 150 kg
- Damaged or bent felling lifter have to be replaced immediately



Code	No.	Test seal	L	
1592491	<b>OX 58-0800</b>	KWF	800	2800
1592505	<b>OX 58-1200</b>	KWF	1300	3600



## OX 52 Tong

- Forged pattern, tips hardened
- With non-slip, ergonomic handle of cork
- Jaw width 265 mm



Code	No.	Test seal	
2231379	<b>OX 52-0000</b>	KWF	985



## OX 53 Tong

- Forged pattern, tips hardened
- High-quality 2-component handle of cork and plastic
- Non-slip and ergonomic
- Handle with recessed grips
- Jaw width 185 mm



Code	No.	Test seal	
1609742	<b>OX 53-0000</b>	KWF	480



## OX 59 Aluminium turning hook

- Ideal for turning of log parts and whole tree trunks
- Especially suitable for large dimension timber
- Made of high-quality aluminium
- With robust steel hook for firm grip
- Non-slip due to additional bent tip
- Functional and robust
- Firm grip due to additional rubber handle
- Tube length 1.46 m, total length 1.56 m
- Max. opening 40 cm



Code	No.	Test seal		
1980998	OX 59-1500	KWF		4900



## OX 51 Turning hook

Black Forest pattern

- For moving and pulling tree trunks
- Forged of chrome-vanadium steel
- Due to the bulge the size is adjustable and the tool is suitable for various trunk diameters



Code	No.	Test seal	Ring Ø	↳ mm ‹	
1592440	OX 51-0000	KWF	125	400	1600



## OX 50 Z Pulling hook

- For safe pulling and lifting when clearing smallwood
- Ground tips for firm grip
- With non-slip, ergonomic handle of cork



Code	No.	Test seal		↳ mm ‹	
2231395	OX 50 Z-0000	KWF		210	370



## OX 50 P Hook

- For safe lifting, transport and setting of plywood
- Ground tips for firm grip
- With non-slip, ergonomic handle of cork



Code	No.	Test seal		↳ mm ‹	
2231387	OX 50 P-0000	KWF		270	415



# CANT HOOKS

A small tool yet with a big impact



## Resilient and robust

Cant hooks are for use wherever wood is picked up, lifted, stacked or turned. For instance when splitting firewood - and then picking it up and transferring it to the stacking pile. A cant hook not only saves on one's energy but also ergonomically relieves the user's back. These useful aids act as an extended arm. Once the cant hook tip has bitten deep into the wood, then simply lift up the

split wood - with no bending down involved. Each OCHSENKOPF cant hook has its own individual advantage: The OX 172 A aluminium cant hook is extremely light. The OX 173 E cant hook with wooden handle is the tried-and-tested traditional variant with the OX 173 K cant hook complete with plastic/fibre glass handle representing the resilient, sturdy type.



## OX 173 K Hand hooker

- For moving and picking up small tree trunks and moving lumber
- For ergonomic working, kind to the back
- With plastic handle: hard plastic in the upper handle, softer plastic grip area and fibreglass core
- With secured head

Can be used with the holder for hooker OX 126-0000 (page 33)



Code	No.	Test seal	 mm	Head 	
2478099	<b>OX 173 K-0500</b>	KWF	380	500	930





## OX 173 E & H Hand hooker

- For moving and picking up small tree trunks and moving lumber
- For ergonomic working, kind to the back
- With high-quality ash handle (OX 173 E-0500) or hickory handle (OX 173 H-0580)

Can be used with the holder for hooker OX 126-0000 (page 33)





Code	No.	Test seal	 mm	Head 		Spare handle
1592408	<b>OX 173 E-0500</b>	KWF	380	500	775	OX E-78 E-0380
2976463	<b>OX 173 E-0600</b>	KWF	600	500	1020	OX E-78 E-0600
1949365	<b>OX 173 H-0580</b>	KWF	800	500	1100	OX E-78 E-0800



## OX 172 A Aluminium hooker

- For moving and picking up small tree trunks and moving lumber
- For ergonomic working, kind to the back
- Handle made of high-quality aluminium
- The special geometry of the tip guarantees a firm grip in the wood
- High stability, reliable hold, lightweight
- With handy plastic grip, additional hook at the handle prevents from slipping off





Code	No.	Test seal	 mm	
1976176	<b>OX 172 A-0500</b>	KWF	500	500
1976168	<b>OX 172 A-0700</b>	KWF	700	580
2294478	<b>OX 172 A-0900</b>	KWF	900	760



## OX 172 SCH Aluminium hooker

with cutting edge

- For moving and picking up small tree trunks and moving lumber
- With additional cutting edge on the rear side for quick cutting of wood fibres
- Due to its double-function the hooker turns into a hatchet by turning it and thus replaces an additional tool while working
- For ergonomic working, kind to the back
- Handle made of high-quality aluminium
- The special geometry of the tip guarantees a firm grip in the wood
- High stability, reliable hold, lightweight
- With handy plastic grip, additional hook at the handle prevents from slipping off



Code	No.	 mm	 g
2937476	OX 172 SCH	500	560



## OX 171 E Hooker

Tirol pattern, toothed type

- For moving and pulling tree trunks
- With additional toothing for extra grip in frozen wood
- With high-quality ash handle

Code	No.	 mm	Head  g	 g	Spare handle
1592351	OX 171 E-1102	1100	1100	2100	OX E-76 E-1100
1592386	OX 171 E-1302	1100	1300	2300	OX E-76 E-1100



## OX 70 E & H Slashing hook

- For chopping and removing small growth, e.g. shrubs, roots, twigs and small branches
- Forged pattern
- With additional cutting edge on the back
- With high-quality handle in ash (OX 70 E-) or hickory (OX 70 H-)



Code	No.	Execution	Test seal	Blade  ← mm →	Head ⚖ g	Weight ⚖ g	Spare handle
1592106	<b>OX 70 E-0901</b>	for two-hand use	KWF	900	900	1600	OX E-90 E-0900
1592122	<b>OX 70 H-0905</b>	for one-hand use	KWF	450	900	1300	OX E-98 H-0450



## OX 252 K Gertl Swiss pattern

- Indispensable for cultivation of new growths and removing of small plants
- Blade made from hardened and tempered steel C45
- 2-component plastic handle in modern design
- Soft plastic for non-slip, ergonomic working

Code	No.	Blade  ← mm →	Weight  ← mm →	Weight ⚖ g
2717883	<b>OX 252 K-0500</b>	295	465	640



## OX 252 T Pouch for Gertl Swiss pattern

- Practical pouch for safe transport and keeping
- Suitable for Gertl Swiss pattern no. OX 252
- With push-buttons for quick closing and a belt loop
- From robust, easy to clean polyester

Code	No.	Weight ⚖ g
2794012	<b>OX 252 K-0000</b>	165





## OX 125-0000 Professional forestry belt

- Real leather belt with robust double perforation
- Stabilising padding at the lower back produces an evened weight distribution, a stable hold and superior comfort
- Inside of the padding with perforations for optimal air circulation
- 45 mm belt width; 130 mm maximum back padding width
- Detachable padding; leather belts also individually for use
- Fits waist size from 80 to 120 cm (32"-48")

Code	No.			
2907054	OX 125-0000			440

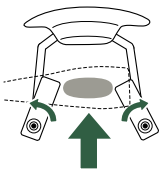

## OX 126-0000 Holder for hooker

- Practical holder for hand hooker OX 173
- For safety and convenience
- Snap hook for easy fitting
- From robust, easy to clean polyester
- Tool holder from stainless steel swings to both sides

Code	No.	H	W	
2646978	OX 126-0000	160	105	140



## OX 127-0000 Holder for wedges

- Practical holder for aluminium and plastic wedges
- Two large compartments provide a secure hold for two wedges. Alternatively, an OCHSENKOPF tong or a pulling hook can be carried along in the back pocket
- Can also be combined with broad belts thanks to a large belt loop
- From robust, easy to clean polyester

Code	No.	H	W	
2821095	OX 127-0000	320	140	160

# CARPENTER'S TOOLS



## OX 410 Mortise axe

- For working timber faces, e.g. wooden beams
- Made of chrome-vanadium steel
- Cutting edge(s) fine polished



Code	No.	Execution	Blade  mm	mm	
1592874	<b>OX 410-4500</b>	3-edge, with chamfer	45	450	1150



## OX 350 - OX 355 Adzes

- For hollowing work, e.g. on tree trunks
- Cutting edge fine polished
- Delivery without handle



Code	No.	Description	Blade  mm		Spare handle	  mm
1592890	<b>OX 350-0850</b>	Straight adze 85 mm	85	1150	OX E-91 E-0800	800
1592912	<b>OX 355-0700</b>	Curved adze 70 mm	70	1150	OX E-91 E-0800	800



## OX 370 Drawing knife

- For drawing wooden beams
- With riveted blue grips
- Cutting edge fine polished

Code	No.	Cutting width	Cutting length	
1593021	<b>OX 370-2250</b>	35	225	450
1593048	<b>OX 370-2500</b>	35	250	500



## OX 375 Drawing knife

light pattern

- For drawing wooden beams
- With riveted black grips





Code	No.	Cutting width	Cutting length	
1593056	<b>OX 375-2250</b>	35	225	400
1593064	<b>OX 375-2500</b>	35	250	450



## OX 395 E Carpenter's bundle axe

- Cutting edge fine polished
- With high-quality ash handle, straight







Code	No.					Spare handle
1592858	<b>OX 395 E-1601</b>	1600	90	800	2350	OX E-82 E-0800



## OX 345 H Carpenter's hatchet

- With forged nail-claw
- Double-sided cutting edge fine polished
- With high-quality hickory handle

Code	No.					Spare handle
1593005	<b>OX 345 H-1102</b>	1100	120	380	1400	OX E-83 H-0390



## OX VS 24 Sales stand

24 pieces

- The rustic styling of this sales stand is an eye-catcher in any showroom
- Appealing presentation of all products from the OCHSENKOPF core range
- At just 110 cm tall, 68 cm wide and 75 cm deep, this silent sales assistant is compact enough to fit anywhere

### Contents

1 piece each:

**OX 235 E-0802** Forestry hatchet 800 g  
**OX 232 E-0602** Hatchet 600 g\*  
**OX 232 E-0802** Hatchet 800 g\*  
**OX 10 H-0807** ILTIS®-Axe 800 g  
**OX 39 H-3009** Splitting hammer 3 kg\*

2 piece each:

**OX 45-0650** Alu hollow-wedge  
**OX 42-1050** Aluminium massive wedge 1050 g  
**OX 42-0550** Aluminium massive wedge 550 g  
**OX 20 H-1257** Forestry axe 1250 g  
**OX 635 H-3009** Wood splitting hammer BIG OX® 3 kg

3 piece each:

**OX 244 E-1251** SPALT-FIX® Hatchet 1250 g  
**OX 205 E-1252** Axe 1250 g\*  
**OX 248 E-2501** SPALT-FIX® Axe 2500 g

\* No. OX 232, OX 39 and OX 205 are not catalogue articles

Code	No.	
1737147	<b>OX VS 24</b>	165



## OX VS 24 R Sales stand ROTBAND-PLUS

24 pieces

- The rustic styling of this sales stand is an eye-catcher in any showroom
- Appealing presentation of all products from the OCHSENKOPF core range
- At just 110 cm tall, 68 cm wide and 75 cm deep, this silent sales assistant is compact enough to fit anywhere

### Contents

1 piece each:

**OX 45-0650** Alu hollow-wedge  
**OX 41-0000** Twisted aluminium splitting wedge  
**OX 235 E-0802** Forestry hatchet 800 g  
**OX 173 E-0500** Hand sapphire 380 mm  
**OX 173 H-0580** Hand sapphire 800 mm  
**OX 270 GST-600** All-steel hatchet  
**OX 10 H-0807** ILTIS®-Axe 800 g  
**OX 20 H-1257** Forestry axe 1250 g  
**OX 30 E-2751** Splitting axe 2750 g  
**OX 620 H-1257** Universal forestry axe ROTBAND-PLUS 1250 g  
**OX 644 H-1255** SPALT-FIX®-Hatchet ROTBAND-PLUS 1250 g  
**OX 648 H-1257** SPALT-FIX®-Axe ROTBAND-PLUS 1250 g

2 piece each:

**OX 42-1050** Aluminium massive wedge 1050 g  
**OX 42-0550** Aluminium massive wedge 550 g  
**OX 244 E-1251** SPALT-FIX® Hatchet 1250 g  
**OX 248 E-2501** SPALT-FIX® Axe 2500 g  
**OX 635 H-3009** Wood splitting hammer professional BIG OX® 3 kg  
**OX 648 H-2508** SPALT-FIX®-Axe ROTBAND-PLUS 2500 g

Code	No.	
1981048	<b>OX VS 24 R</b>	165



## OX 33-0200 Grindstone

- Combined grindstone and whetstone made of silicon carbide, with rounded edges
- This material is considered to be amongst the hardest and best grinding abrasives, and is ideally suited for tools with predominantly flat cutting edges, including axes, hatchets, chisels and knives
- One side with coarse grain (120) for fast grinding
- One side with fine grain (320) for fine grinding and honing

### Uses:

- With light oil for a fine honed finish
- With paraffin for a normal ground finish
- With water for a coarser ground finish
- Dry for particularly heavy material removal

Code	No.	L	W	H	
1785419	OX 33-0200	125	50	20	200



## OX E-123 Accessories

for safety wedging of handles

Code	No.	Description	
1593897	OX E-123-0150	Fitting set for hand sappers + hatchets, 3 pcs	8
1997238	OX E-123-0125	Fitting set for wood splitting hammers, 3 pcs	12
1593889	OX E-123-0100	Fitting set for axes, 3 pcs	12
1693867	OX E-123-0200	Fitting set for heavy hatchets, 3 pcs	12

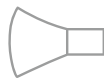

## Tips for re-sharpening the blade:

**1** Blunted cutting edges can be re-sharpened by using a whetstone.

**2** When sharpening, it is important to ensure that the original geometry of the cutting edge is retained. First of all run the coarse side of the stone over the cutting edge with circular movements. Then use the fine-grain side to achieve the final sharpening.

**3** Different sharpening results can be achieved by use of lubricants, e.g. oil or water.

# SAFETY NOTES

## General safety notes

- Never beat steel on steel (for example, hammer or axe against axe). Also steel wedges must be driven in only with a hard wood or plastic hammer. Beating steel on steel can lead to splintering and cause severe accidents.
- Aluminium and plastic wedges must be driven in with appropriate tools such as a splitting hammer. Only these tools are permanently suitable for driving in wedges due to their special design.
- Use tools only for their intended purpose. Example: using the axe as a hammer is not using it for its intended purpose.
- Check the tool before each use. There must be no material cracks on the head and handle. The head must be securely attached to the handle.
- Wear appropriate protective clothing, for example safety glasses, gloves and safety shoes.
- Do not use these tools for lateral leverage
- Use only original spare parts and spare wedges. To ensure a secure fit and therefore a secure joint between the head and the handle, the dimensions must precisely match.



## Care and storage notes

- The correct care of your tool significantly extends the life.
- It is therefore important to always store the tool properly.
- Storage in dry air allows the handle to quickly dry out.
- Storage in conditions which are too damp can cause the wooden handle to swell up, and this permanently damages the fibres in the wooden handle.
- When storing the tool for a longer period, apply some oil or grease to the blade to protect it from rust.
- Blunt blades can be re-sharpened by regrinding.
- Always ensure that the tool is kept in a perfect condition.
- The cutting edge should be covered by an appropriate blade protector.
- A dried-out loose-fitting handle is a safety risk and should be immediately exchanged by a new, original spare part.

## Safety notes for wedges

- Aluminium and plastic wedges must be driven in with appropriate tools such as a splitting hammer. Only these tools are permanently suitable for driving in wedges due to their special design.
- Given lengthy use, burr may develop on the striking plate of the aluminium wedge. It could be sharp-edged and should be removed, for instance, by sanding down.
- Never beat steel on steel: this can lead to splintering and cause severe accidents. Steel wedges must be driven in only with a hard wood or plastic hammer.

# 16 17

## Disclaimer and general information

This catalogue replaces all previous issues. Photographs and technical information are current at the time of publication.

In the course of improvement and adaptation to meet the latest technical practice, we reserve the right to make changes with regard to the appearance, dimensions (always in mm unless otherwise stated), weights properties and performance. This does not provide entitlement to any claim for correction or redelivery of products already supplied. Products can be deleted at any time without this giving rise to any legal claim.

Notes and advice on use and safety are non-binding. They do not in any way replace legal or trade association regulations.

We cannot accept any liability for printing errors. No supplemental items are included in the scope of supply.

No information presented here, even in extract, may be reprinted without the prior written consent of GEDORE.  
All rights reserved, worldwide.

We refer to our current outline and condition agreements and to our supply and payment terms and conditions, set out in the publisher's details at [www.gedore.com/impressum](http://www.gedore.com/impressum)

**Overall concept:**

GEDORE Werkzeugfabrik GmbH & Co. KG  
Remscheider Straße 149  
42899 Remscheid · GERMANY

T +49 2191 596 - 0  
F +49 2191 596 - 230  
[info@gedore.com](mailto:info@gedore.com)  
[www.gedore.com](http://www.gedore.com)

**Brands of the GEDORE Group**

[gedore.com](http://gedore.com) · [carolus.de](http://carolus.de) · [ochsenkopf.com](http://ochsenkopf.com)

**Concept, graphic production and design:**

Mirum Agency GmbH  
Rather Straße 49 d  
40476 Düsseldorf · GERMANY

© Copyright by GEDORE Remscheid

This catalogue is printed on recyclable and chlorine-free bleached paper.

**Sales and service**

GEDORE Werkzeugfabrik GmbH & Co. KG  
Remscheider Straße 149  
42899 Remscheid · GERMANY

T +49 2191 596-0  
F +49 2191 596-230  
info@gedore.com

**Sales Germany**

T +49 2191 596-900  
F +49 2191 596-999

**Sales International**

T +49 2191 596-910  
F +49 2191 596-911

